



NT 460

Operators Manual



Ft. Atkinson, Wisconsin USA



Panningen, The Netherlands

www.digi-star.com

TABLE OF CONTENTS

TECHNICAL SPECIFICATIONS	1
SAFETY DURING USE	2
Cleaning	2
Charging Battery and Welding	2
NT 460 FEATURES	3
INDICATOR OVERVIEW	4
INDICATOR DISPLAY SCREENS	8
FIELD SCREEN	9
ID SCREEN	10
GPS ACTIVE SCREEN	11
GPS SPREADING SCREEN	12
LAST LOAD SUMMARY SCREEN	13
GPS Satellite Screen	14
OPERATION	15
Turn On Indicator	15
Zero Balance Indicator	15
Set Application Width	16
Set Application Rate	16
Application Rate Tolerance	16
Audio Alarm	16
GPS SPREADING FUNCTIONS	17
Start/Stop Display	17
TRANSFER DATA	19
GPS Satellite Display Information	20
GPS Accuracy	20
Nutrient Tracker Mapping Capability	20
Nutrient Tracker Print Format	21
GPS Records Format	21
DAILY DATA COLLECTION	22
Indicator Memory	22
Mid-Season Name Changes	22
Modify Field Names and ID	23
Clearing the Indicator Memory	24
Erase Nutrient Tracker™ Data Records	24
Zero Weight Accumulator	24
Zero Acres Accumulator	25
OTHER FUNCTIONS	26
Using Dimmer Option	26
Change Time	26
Change Date	26

NON-GPS OPERATION	27
Indicator Display Screens	28
Active Screen	29
Last Load Summary Screen	30
Record Data	31
Recorded Data Preview	31
Other Functions	32
Unload Alarm	32
WEIGHING ERRORS	32
Over-Capacity Limit (<i>OVERCAP</i>)	32
Over Range (<i>+RANGE</i>)	32
Under Range (<i>-RANGE</i>)	32
MENUS AND CALIBRATION	33
RE-CALIBRATING YOUR SCALE	37
Get Your Calibration Number	38
Change Setup and Calibration Numbers	38
INSTALLATION	39
Indicator Mounting	39
Cable Connection	40
Bottom Panel Cable Connections	40
Connect Load Cells to J-Box	41

All rights reserved. Reproduction of any part of this manual in any form whatsoever without Digi-Star's express written permission is forbidden. The contents of this manual are subject to change without notice. All efforts have been made to assure the accuracy of the contents of this manual. However, should any errors be detected, Digi-Star would greatly appreciate being informed of them. The above notwithstanding, Digi-Star can assume no responsibility for errors in this manual or their consequence.

© Copyright! 2008 Digi-Star, Fort Atkinson (U.S.A.).

TECHNICAL SPECIFICATIONS

SIZE

10.25" long x 8.0" high x 4" wide (260mm x 190mm

DISPLAY RESOLUTION

.01, .02, .05, .1, .2, .5, 1, 2, 5, 10, 20, 50, 100

WEIGHT

4.5 lbs (2.04 Kg)

DISPLAY UPDATE RATE

Selectable: 1, 2, 3, 4 times/sec.

HELP MESSAGES

Context sensitive help messages in 10 languages

Long messages are scrolled

MAX. DISPLAY RESOLUTION

Adjustable to 40,000 counts max.

TRANSDUCER EXCITATION

8 volts D.C. Nominal

Capable of driving ten 350 Ohms transducers
Short circuit proof

ZERO TRACKING

Selectable, On/Off

ATC

Auto Temperature Compensation of the internal circuitry for high accuracy weighing measurements

SPAN ACCURACY

$\pm(.1\% + .005\%/^{\circ}\text{F})$ or $(.1\% + 0.009\% ^{\circ}\text{C})$ full scale ± 1 output count

TRANSDUCER SIGNAL

Compatible with transducers having full scale indicator transfer characteristics greater than 0.25 mv/v

MOTION DETECTION

Selectable, On/Off

"AUTO RANGE"

(Selectable) To increase display counts at weight values of 300 and 600 display counts.

ZERO ACCURACY

$(.005\%/^{\circ}\text{F})$ or $(0.009\% ^{\circ}\text{C})$ full scale ± 1 output count for 0.5 mv/v transducer

CONNECTOR

AMP plastic weather resistant circular connector. Gold contacts.

ENVIRONMENTAL ENCLOSURE

IP65, IEC 529

POWER REQUIREMENTS

10.5 to 16.0 V.D.C.

160 mA nominal with four 350 Ω L.C.

WEIGH ALGORITHM

4 internally selectable digital filters to optimize performance
(General, Slow, Fast and Lock-on)

SET UP AND CALIBRATION

Via front panel

HOLD MODE

Used in mobile applications to stabilize displayed weight while moving the scale

GROSS RANGE

999,999 max. display

NON-VOLATILE MEMORY

EEPROM for balance

LOW BATTERY WARNING

Enabled at 10.5V nominal

OPERATING TEMP

-29 $^{\circ}\text{C}$ to 60 $^{\circ}\text{C}$

-20 $^{\circ}\text{F}$ to 140 $^{\circ}\text{F}$

POUND/KILOGRAM

Selectable

REMOTE INPUTS

Tare / Advance Recipe / Re-enter Preset

DISPLAY

STD EZ 6 Digit LCD 1.0. high

EZ VIEW 6 Digit LCD 1.7" high

SAFETY DURING USE



Caution

Cleaning

Do not use running water (high pressure cleaners, hoses) to clean the indicator.

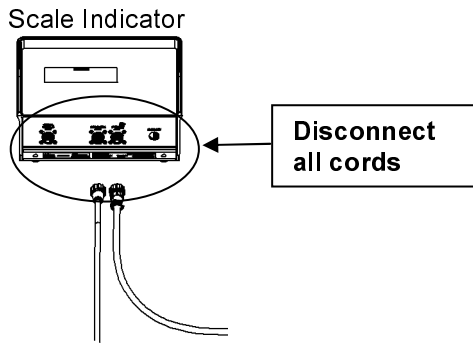

Charging Battery and Welding

Disconnect all cables from the weighing indicator before charging the battery or welding on the machine. If cables are left connected, the weighing indicator and connected load cells could be damaged.



NT 460 FEATURES

One Button Operation

The NT 460 indicator has many features but it also boasts simple operation using  before unloading and again after unloading.  Weight, date, time and additional notes are all stored automatically using only .

USB Port

USB drive has capacity to hold thousands of data records and allows easy data transfer to your office PC.

Nutrient Tracker™

Nutrient Tracker™ software provided with NT 460 indicator allows generation of a variety of reports on your PC. Reports can be read by programs such as Microsoft Excel™, Adobe Acrobat™ and Microsoft Internet Explorer™.

Memory Capacity

When using the GPS, the NT 460 can store 32 hours of data with GPSSTR while sampling once every 10 seconds. This equals about 400 loads at 9 minutes per load.







Operating the NT 460 without GPS unit

See “Non-GPS Operation” on page 27.

INDICATOR OVERVIEW



- ① **FIELD** – Enter and exit Field screen (See page 8).
- ② **START STOP** – Start or stop unloading operation.
- ③ **ZERO** – Press and hold to zero balance the scale.
- ④ **GPS Satellite Display** (See page 20).
- ⑤ **ID** – Enter and exit ID screen.
- ⑥ **ON** – Turn indicator on.
- ⑦ **OFF** – Turn indicator off.
- ⑧ Upper Display Window – Displays current actions or weight – 6 characters.
- ⑨ Lower Display – Displays recorded data – 26 characters x 3 rows.
- ⑩ **ENTER** – Accept change or proceed to next item.
- ⑪ Directional Arrows – Left or right arrows move cursor inside data field. Up and down arrows move to previous or next data field. List scrolls faster the longer the Up/Down arrow is held down.

- ⑫ Qwerty Keyboard
- ⑬  – Escape or undo last data change.
- ⑭ Numbers Keypad
- ⑮  – Performs task displayed by select.
- ⑯  – Scroll thru function key operation.
- ⑰  – For additional information.
- ⑱  – Delete one character in data entry field. Press and hold to delete entire data entry field contents.
- ⑲  – Press and release. Then press key with desired special character.
- ⑳  - Press to backspace. Press and hold to backspace faster.

Bottom Panel Connections

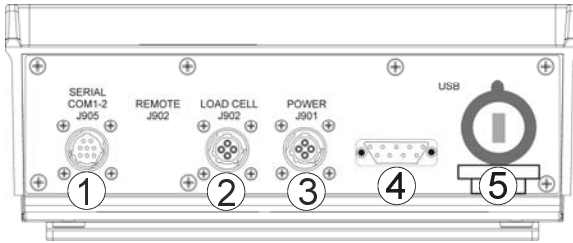

- ① Serial/Printer – Used to communicate with computer, data downloader (DDL) or printer.
- ② Load Cell
- ③ Power – 12VDC
- ④ GPS – Port for GPS connection
- ⑤ USB – Port for USB drive

GPS Data Records

A GPS data record includes data recorded periodically while unloading:

- GPS coordinates
- Application rate
- Gross weight
- Speed

The GPS data record also includes the load information calculated and stored once each time a load is concluded by pressing . This data includes:

- Field name
- ID
- GPS coordinates
- Time
- Date
- Application rate set
- Application width set
- Elapsed time
- Weight unloaded this load
- Acres (Hectares) spread this load
- Calculated application rate for load
- Weight unloaded this field
- Acres (Hectares) spread this field

INDICATOR DISPLAY SCREENS

Five display screens can be shown on the Indicator:

Field Screen

150 field names are available and can be modified using the keypad.
See page 9.

ID Screen

150 ID names are available and can be modified using the keypad.
See page 10.

GPS Active Screen

This screen is shown before pressing  to start spreading. Upper display shows gross weight while lower display includes speed, compass direction, application rate, spread width, total and field name.
See page 11.

GPS Spreading Screen

Press  before unloading to view GPS spreading screen. Upper display shows the current rate tons/acre (tonnes/hectare) while lower display includes speed, compass direction, target application rate, time since start of unloading, gross weight, NET weight unloaded, acres covered this load, and actual vs. target rate indicator. See page 12.

Last Load Summary Screen (temporary)

Screen display last load weights for 10 seconds after pressing  to complete a load. See page 13.

GPS Satellite Screen

Press  to view GPS Satellite Screen. This screen shows latitude, longitude, MPH, status and universal time clock. See page 14.

FIELD SCREEN

Note: Field names can be uploaded from a PC using a USB drive. See page 15.

Field names can be a maximum of 26 characters long.

Field names can be changed using the keypad before unloading.



- ① Press **FIELD** to modify or select field. Current field number is shown in upper display.
- ② Three lines are displayed in Lower Display Window. The top line of the three is current, editable and will be used for next data record.
- ③ Use keypad to enter or update field names. Press **BACK SPACE** to delete characters to left and **CLEAR** to delete the selected character. Hold **CLEAR** to delete entire line. Pressing **ESC** will reset line to last saved data.
- ④ To use special characters press and release **SHIFT LOCK**. Then press key with desired special character. Repeat for each special character required.
- ⑤ Press **ENTER** or **FIELD** to exit.
- ⑥ Up/Down Arrows – Press **▲** or **▼** to scroll through fields (150 maximum). Hold arrow to scroll faster. Use **◀** or **▶** to move cursor within data line.

ID SCREEN

Note: ID names can be uploaded from a PC using a USB drive. See page 15.

ID names can be a maximum of 6 characters long.

ID names can be changed by using the keypad before unloading.



- ① Press **ID** to modify or select ID name. Current ID number is shown in upper display.
- ② Three lines are displayed in Lower Display Window. The top line of the three is current, editable and will be used for next data record.
- ③ Up/Down Arrows – Press or to scroll through ID names (150 maximum). Hold arrow to scroll faster. Use or to move cursor within data line.
- ④ Use keypad to enter or update ID names. Press **BACK SPACE** to delete characters to left and **CLEAR** to delete the selected character. Hold **CLEAR** to delete entire line. Pressing **ESC** will reset line to last saved name.
- ⑤ To use special characters press and release **SHIFT LOCK**. Then press key with desired special character. Repeat for each special character required.
- ⑥ Press **ENTER** or **ID** to exit.

GPS ACTIVE SCREEN

The 3-line display will show the following information:



- ① Upper Display Window – Displays the gross weight.
- ② **NW** – Compass direction as read from the GPS.
- ③ **MPH (or KMH)** – Miles per Hour (or Kilometers per Hour) as read from the GPS.
- ④ **SPDR-1** – 6 character ID description.
- ⑤ **FIELD** – 26 character field description (entered by operator).
- ⑥ **TO** – Total amount of manure applied to field.
- ⑦ **TAC** – Total Acres/Hectares spread this field.
- ⑧ **W** – Spread width of the spreader entered by the operator in feet (or meters).
- ⑨ **T/A** – Application rate entered by operator in Tons/Acre (or Tonnes/Hectare).

Note: Print format *PRTFM* must be set to *NUTRINT*.

GPS SPREADING SCREEN



- ① Upper Display Window – Displays the current rate tons/acre (tones/hectare) weight.
- ② **MPH (or KMH)** – Miles per Hour (or Kilometers per Hour) as read from the GPS.
- ③ **GR** – Gross weight left on spreader.
- ④ **NE** – Net weight spread this load.
- ⑤ **APPLICATION RATE INDICATOR** – Actual rate of application, measured by scale in Tons/Acre (or Tonnes/Hectare). The indicator will be centered when the actual application rate is equal to the target application rate.
- ⑥ **AC** – Acres (Hectares) this load.
- ⑦ Elapsed time.
- ⑧ **T/A** – Application rate entered by operator in Tons/Acre (or tonnes/hectare).
- ⑨ **NW** – Compass direction as read from the GPS.

Note: Print format *PRTFMT* must be set to *MUTRNT*.

LAST LOAD SUMMARY SCREEN (Temporary)



This screen is displayed to 10 seconds after pressing **START STOP** to complete a load. Press **ESC** to review this screen for 10 seconds.

- ① **Upper Display Window** – Displays the current gross weight.
- ② **Field Name**
- ③ **Net Weight** – Weight unloaded this load.
- ④ **Acres** – Acres spread this load.
- ⑤ **Ton/Acres** – (Tonnes/Hectare) this load.
- ⑥ **Total Weight** – Weight unloaded this field.
- ⑦ **Total Acres** – Acres spread this field.

GPS Satellite Screen

- ① **Upper Display Window** – Displays the current gross weight.
- ② **LA/LO** – Latitude and Longitude GPS coordinates.
- ③ **N** – GPS Compass Direction
- ④ **MPH (or km/h)** – Miles per Hour (or Kilometers per Hour) as read from the GPS.
- ⑤ **UTC** – Universal time clock from the GPS.
- ⑥ **SAT** – Satellite status from the GPS.

OPERATION

Turn On Indicator



1. Press 



Zero Balance Indicator



1. Press and hold  for 3 seconds to zero balance indicator.
2. Flashing arrow points to gross next to the display window, indicator ready to weigh.

Set Application Width



1. Press . *WIDTH* will display.
2. Press .

Note: The value is decimal – 40 should be entered as 400. The display will show 40.0.

Note: Width should not be entered very often.

Note: The GPS Measurement Unit Value (*RUNIT*), menu 3 in Setting Options, see page 33, will determine the unit of measure.

Set Application Rate

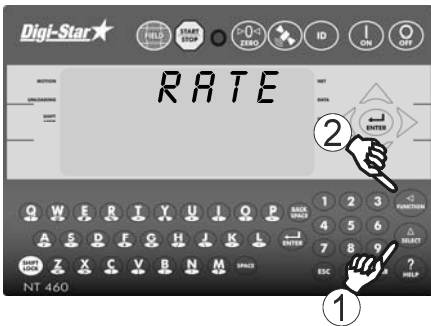

1. Press . *RATE* will display.
2. Press .

Note: The value is decimal – 40 should be entered as 400. The display will show 40.0.

Note: The GPS Measurement Unit Value (*RUNIT*), menu 3 in Setting Options, see page 33, will determine the unit of measure.

Application Rate Tolerance

Activate alarm by changing the Tolerance (Menu 4, D.A.N. 442, *TOLER*) from OFF to .5, 1, 2, etc. Tolerance is in Tons/Acre or Tonnes/Hectare. Default is OFF. The front panel light and beeper will periodically sound when the Actual Application Rate varies from the Rate Set by the tolerance selection.

Audio Alarm

Press 404 (*SELECT*) to enter buzzer menu. Select OFF or ON. 1 – 4 are not used.

GPS SPREADING FUNCTIONS

These functions apply only when the optional GPS is connected to the NT 460.

Start/Stop Display



1. Press  to start unloading.
2. Unit will display the GPS Spreading Screen (see page 12).

Application Rate Low - when unload annunciator is left of center. Decrease driving speed or increase apron speed.



Correct Application Rate - when unload annunciator is centered.



Application Rate High - when unload annunciator is right of center. Increase speed or decrease apron speed.



3. Press **START STOP** when unloading is complete.

4. For ten seconds the display will show the Last Load Summary Screen (see page 13).

5. The indicator now sends the weight and field information out the printer port.



6. The indicator will return to GPS Active Screen.

Note: If you wish to view the Last Load Summary Screen press **ESC**

TRANSFER DATA

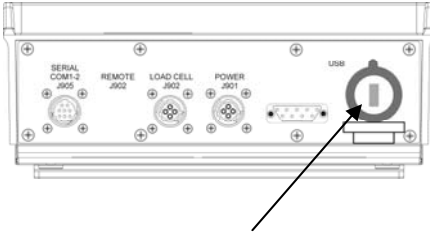

Insert USB drive here to download data records

The indicator is equipped with a USB drive port. The USB drive used with the indicator holds thousands of data records and allows for easy transfer to PC.

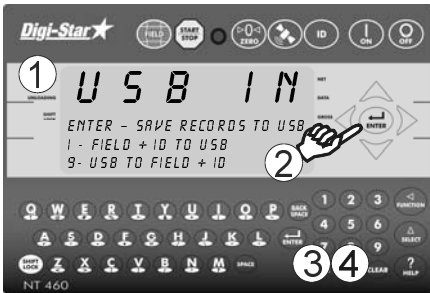

1. Insert USB drive. Indicator will automatically detect the USB drive
2. Press  to save records to USB drive.

Note: This action appends values already on the USB drive. No data is lost.

Note: It takes five minutes to download data when memory is 25% full.

3. Press 1 to transfer Field, ID, Total Weight, and Acres Data from Indicator to USB. **Note:** This is only necessary if Field or ID data has been modified using indicator keypad.
4. Press 9 to transfer Field, ID, Total Weight, and Acres data from USB drive to indicator.



Important: This action will overwrite Field names, ID names and Accumulator values in the indicator.

GPS Satellite Display Information

When the GPS module detects a satellite, the “SAT” tag shows either *NO GPS* (No Satellites Detected), *GPS-15* (standard 15 meter accuracy) or *DGPS-3* (Differential Global Positioning System with 3 meter accuracy). Latitude, Longitude, Compass Direction, Miles per Hour and Universal Coordinated Time (UTC) are also displayed. UTC always updates when GPS is connected. The previous locations latitude and longitude will display until satellites are found again.

The six-digit weigh screen normally displays the Gross weight of the spreader. The 3-line display will show the following information.



1. LA = Latitude; LO = Longitude
2. NW = Compass direction
3. MPH (or KMH) = Miles
4. SAT fix = NO GPS, GPS-15, or DGPS-3
5. UTC = Coordinated Universal Time. This also identifies the GPS is transmitting data.

GPS Accuracy

Differential Correction GPS (DGPS), such as the Wide Area Augmentation System (WAAS), covers the USA and provides accuracy from 1 to 3 meters. Most developed countries have some type of DGPS. Standard GPS is available globally, and is accurate to 15 meters (49.2 feet).

Nutrient Tracker Mapping Capability

Nutrient Tracker uses GPS and weight information collected from the NT 460 and creates reports that overlay delivery areas on satellite images for nutrient management and record keeping. Nutrient Tracker can also export standard “CSV” and “shape” files for use in other mapping programs.



Note: Mapping requires an internet connection.

Nutrient Tracker Print Format

Use print format NUTRNT for recording data. The below example shows six lines of printed report.

```

          1           2           3
12345678901234567890123456789012345678
-----|-----|-----|-----
"WIDTH:40.5  RATE SET: 5.0<CR><LF>
"LA:4038.4551 N<CR><LF>
"LO:08848.3669 W<CR><LF>
" 1626070TOT      1020.0TAC<CR><LF>
" 17080LB      1.99AC 24.3T/A<CR><LF>
"FIELD 3                                     <CR><LF>
"ID 3,9/23/09,12:10P<CR><LF>
"T: 2:07<CR><LF>
"<CR><LF>
    
```

The middle 3 lines are displayed after  key is pressed. The other three lines are displayed by pressing  or .

GPS Records Format

The GPS records stored have the following format:

```

          10           20           30           40
1234567890123456789012345678901234567890123456789
-----|-----|-----|-----|-----
ddmm.mmmm,N,dddmm.mmmm,E,rrrr,m,wwwwww,ss.s,kCL
    
```

- ddmm.mmmm - Latitude, ddmm.mmmm format (leading zeros transmitted)
- N - Latitude hemisphere N or S
- dddmm.mmmm - Longitude, ddmm.mmmm format (leading zeros transmitted)
- E - Longitude hemisphere W or E.
- rrrr - Actual Application Rate measured by scale in Tons/Acre (or Tonnes/Hectare).
- m - Actual Application Rate Unit E=Tons/Acre, M=Tonnes/Hectare.
- wwwwww - Gross weight.
- ss.s – Speed in MPH or KPH
- k - Check Sum.
- c - Carriage Return.
- l - Line Feed.

DAILY DATA COLLECTION

Insuring your data is secure from theft, fire or equipment failure requires a small effort each day to store your data on a USB drive.

Indicator Memory

When powering up the NT 460 the memory percent full is shown on the display. The NT 460 has enough memory to store approximately 400 loads while sampling every ten seconds and unloading one load every nine minutes.

It is recommended to download data from the NT 460 to the USB drive before the memory is close to full. It takes just under five minutes to download data when the memory is 25% full and under ten minutes when 50% full.

Mid-Season Name Changes

During the season, you may wish to delete and add field names or ID names to your scale indicator memory. This may be done in one of two ways.

Front Panel

For a small amount of changes, edit field names and ID names using the keypad on the front panel. See page 8 and 10 to edit field names and ID names. See page 24 to erase accumulator memory.

Upload New Field Names, ID Names and Accumulator Using USB Drive

For a large number of changes, perform the changes on your PC using Nutrient Tracker™ software and then transfer the new information to the indicator using a USB drive.

Before doing this, transfer your existing field accumulator data (acres and weight) from the indicator to the USB drive and onto your PC. This keeps the proper accumulator values on partially finished fields.

Modify Field Names and ID

Using Nutrient Tracker™ software:

- Upload data records from USB drive to the PC.
- Delete field names that are already finished and clear their accumulators.
- Add new field names as needed.
- Transfer the new field names, accumulators and ID names onto the USB drive.

Note: *To upload data to indicator, you must first create data files with field names, ID names and accumulator values using Nutrient Tracker™ software.*

Clearing the Indicator Memory

! Important: Before erasing the data records, be sure that the data records have been safely stored.

Erase Nutrient Tracker™ Data Records

! Important: This action will erase all data records.

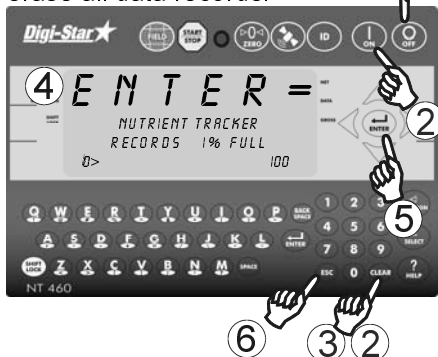

1. Press **OFF**.
2. Hold **CLEAR** and press **ON**. Continue to hold **CLEAR** until **PRINT BUFFER** displays.
3. Release **CLEAR**.
4. Displays scrolls **ENTER = ERASE**
ESC = EXIT.
5. Press **ENTER** erases all records.
6. Press **ESC** to return to active screen without erasing records.

Zero Weight Accumulator

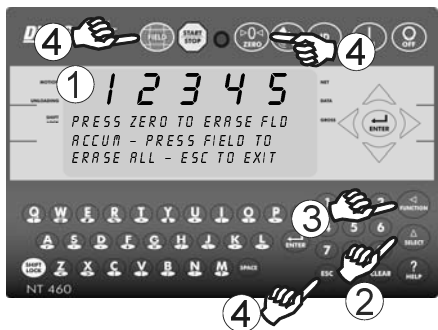

1. Select field name of weight accumulator to be erased. See page 8. Return to the active screen.
2. Press **SELECT** repeatedly until **ACCUM** is displayed.
3. Press **FUNCTION**.
4. Press **ZERO** to delete current field accumulated value, press **FIELD** to erase all 150 accumulated records or press **ESC** to exit.

Note: This operation only erases the accumulator data, field names; ID names and data records are not affected.

Zero Acres Accumulator

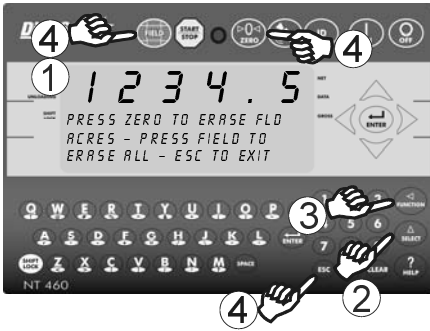



1. Select field name of accumulator to be erased. See page 8. Return to the active screen.
2. Press **SELECT** repeatedly until *ACRES* is displayed.
3. Press **FUNCTION**.
4. Press **ZERO** to delete current field acres value, press **FIELD** to erase all 150 accumulated field records or press **ESC** to exit.

Note: *This operation only erases the acres data, field names; ID names and data records are not affected.*

OTHER FUNCTIONS





Using Dimmer Option

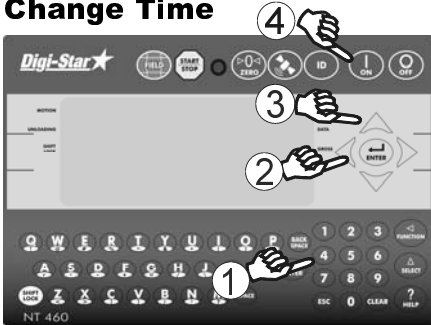

1. Repeatedly press  until *DIMMER* is displayed.
2. Press  dims backlight intensity by 60%. Press  again for full intensity.





Change Time

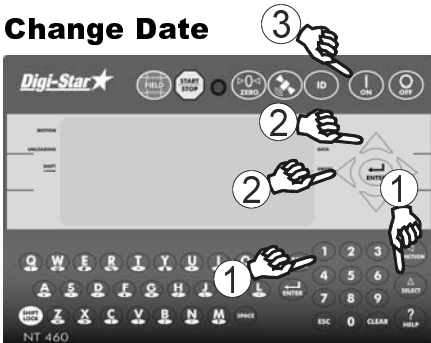

1. Enter **202** and press .
2. Press  to move cursor.
3. Press  to set time.
4. Press .

Change Date



1. Enter **204** and press .
2. Press  to move cursor. Format ddmmyy. Press  to set date.
3. Press .

NON-GPS OPERATION

The following information is to be used while operating an indicator that does not have GPS capabilities.

Without a GPS unit attached, some of the display screens on the NT 460 are different. One record for each load is stored in the indicator memory.

- The data record includes:
 - Field name
 - Weight unloaded
 - Time
 - Date
 - Scale ID
 - Total weight for field

In the non-GPS mode, data from 13,000 loads can be stored in the indicator memory.

Indicator Display Screens

Four display screens can be shown on the Indicator:

Active Screen

Statistics including ID, Time, Gross Weight, Print Accumulator and Field Name. See page 29.

Last Load Summary Screen (Temporary)

Screen display last load weights for 10 seconds after pressing



to complete a load. See page 30.

Field Screen

150 field names are available and can be modified using the keypad.
See page 8.

ID Screen

150 ID names are available and can be modified using the keypad.
See page 10.

Active Screen

Indicator needs to be on this screen before loading or unloading.



- ① Current weight.
- ② Current ID name.
- ③ Current gross weight.
- ④ Current field name.
- ⑤ Net Weight (Unloaded this load)
- ⑥ Time (3:33 PM shown).
- ⑦ Total weight (TO) for current field.

Note: Set print format (DAN 216) to PRTAC5 to operate in non-GPS mode.

Last Load Summary Screen (Temporary)



This screen is displayed to 10 seconds after pressing **START STOP** to complete a load. Press **ESC** to review this screen for 10 seconds.

- ① **Upper Display Window** – Displays the current gross weight.
- ② **Field Name**
- ③ **Net Weight** – Weight unloaded this load.
- ④ **Total Weight** – Weight unloaded this field.
- ⑤ **ID**
- ⑥ **Date**
- ⑦ **Time** – *Note: Press **▲** during this screen to view acres (hectares) and total acres (hectares).*

*Note: This screen is shown for 10 seconds. To view again **ESC**.*

Record Data



1. Press **FIELD** to select required field name. See page 8.
2. Press **ID** to select required ID. See page 10.

Note: Make sure Indicator has returned to the active screen.

3. Press **START STOP** before unloading. Scale will read Zero and enter the net mode.
4. Unload. The Upper Display shows UNLOAD. The Gross and NET weights are displayed on the second line of the Lower Display.
5. Press **START STOP** once the unloading process is complete.

When the unloading process is complete:

- The data record is stored in memory.
- The data record is printed.
- The data record screen will display the last data record for 10 seconds.
- The indicator will return to active screen.

Recorded Data Preview

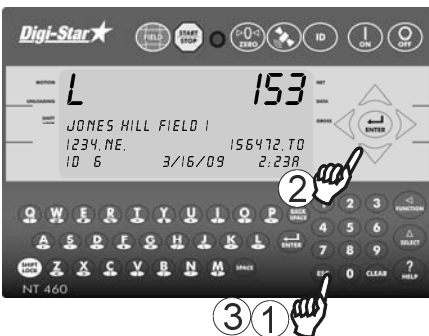

1. Press **ESC** to see last data record.
2. Press **▽** or **△** to scroll record data.
3. Press **ESC** to immediately return to the active screen. After 10 seconds of no keypad activity, the Indicator will return to the active screen.

Other Functions

Unload Alarm

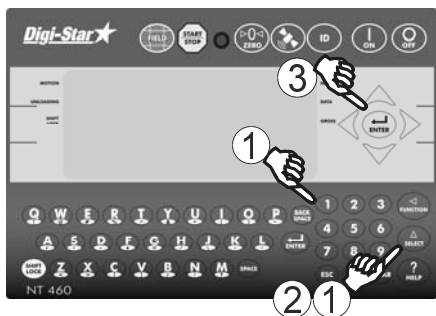

The unload alarm beeper can be set

- to:
- Off – no beep
 - 1 – short beep
 - 2 – medium beep
 - 3 – medium long beep
 - 4 – longest beep



To change unload alarm:

In the active screen:

1. Enter **407** and press 
2. Press  until desired setting is shown.
3. Press  to save setting and return to active screen.

WEIGHING ERRORS

Over-Capacity Limit (*OVRCAP*)

Weight on scale system exceeds capacity limit.

Over Range (*+RANGE*)

Weight on scale system exceeds maximum weight.

Under Range (*-RANGE*)

Weight on scale system less than minimum weight.

MENUS AND CALIBRATION



To modify options in following chart, while on the active screen:

Enter D.A.N. (Direct Access Number) and press  to enter selected option.

Press  repeatedly until desired selection is shown.

Press  to set.

SETTING [display]	D.A.N NO.	OPTIONS [displayed] BOLD=DEFAULT		DESCRIPTION
MENU 1. BASIC FEATURES IN MOST INDICATORS				
Language (<i>LANGRG</i>)	101	English Dutch French German Italian Portuguese Spanish Danish Hungarian Spanish	(<i>ENGLISH</i>) (<i>NEDERL</i>) (<i>FRANCS</i>) (<i>DEUTSH</i>) (<i>ITAL</i>) (<i>PORT</i>) (<i>ESPRM</i>) (<i>DANSK</i>) (<i>MAGYAR</i>) (<i>VESTA</i>)	Select language to be displayed.
Display Update Rate (<i>D-RATE</i>)	102	1,2,3,4		Update display times per seconds.
Motion Arrow (<i>MOTION</i>)	103	ON/OFF		Arrow flashes for unstable weight.
Zero Tracking (<i>ZTRACK</i>)	104	ON/OFF		Set to OFF.
Weigh Method (<i>W MTHD</i>)	105	1=General, 2=Fast, 3=Slow, 4=Lock-On		Use general.

SETTING [display]	D.A.N NO.	OPTIONS [displayed] BOLD=DEFAULT	DESCRIPTION
Scroll (SCROLL)	118	0,1,2,3, 4 ,5,6,7,8,9	Sets scroll rate of Display.
MENU 2. CLOCK, PRINTER, COMMUNICATIONS FEATURES			
Time Format (TIME F)	201	24 HR AM/PM	24-hour time format.
Set Time (TIME)	202	XX:XX:XX	Use  increments each digit and use "ARROW" keys advances cursor to set date "mmdddy" field.
Date Format (DATE F)	203	1,2,3,4,5,6,7,8	Select date format. 1 = mm – dd 2 = mm/dd/yy 3 = mm/dd/yyyy 4 = dd/mm 5 = dd/mm/yy 6 = dd/mm/yyyy 7 = dd/mm/yy 8 = dd/mm/yyyy
Set Date (DATE)	204	Enter XXXXXX	 changes date, "ARROWS" advance cursor to set date.
One Line Print (1L PRT)	212	ON/OFF	Formats printer output to one line.
Computer in Mode (COM IN)	215	DOWNLD , EZ CMD, EZ2CMD	DOWNLD = Data Down Loader, EZ CMD = Original EZ Commands, EZ2CMD = EZII Escape Commands.
Print Format (PRTFMT)	216	NUTRNT , PRTAC5	Use PRTAC5 without GPS. Use NUTRNT with GPS.
Media Type (MEDIA)	217	USB , DDL, Datakey, Ser PC	Use USB.

SETTING [display]	D.A.N NO.	OPTIONS [displayed] BOLD=DEFAULT	DESCRIPTION
Com 1 Delay {C1 DLY}	221	OFF, .10 , .25, .50, .75, 1-5	Printer delay. Set to higher number for slow printing.
Print Accum. {ACCUM}	223	0	Shows a running total of weights printed.
Buffer {BUFFER}	238	ON	Set to ON
PBLine {PBLINE}	239	1,2, 3	Use 3
MENU 3. SCALE CALIBRATION SETTINGS			
Display Count {COUNT}	301	.01,.02,.05,.1,.2,.5,1,2 ,5, 10 ,20, 50,100	Minimum weight change that is displayed. Note: If this is too small, scale will be unstable.
Display Unit {LB-KG}	303	LB/KG	Unit of measure. Note: If this changes, calibration and set-up must change.
Capacity {CRP}	304	85,000	Maximum capacity of scale.
GPS Measurement Unit Value {RUNIT} (only applicable with optional GPS)	322	ENGLISH, METRIC	GPS values entered in English or Metric units.
Rate {RATE}	323	1.X	Enter desired rate in tons/acre (tonnes/hectare).
Width {WIDTH}	324	40.X	Enter spread width in feet (meters).

SETTING [display]	D.A.N NO.	OPTIONS [displayed] BOLD=DEFAULT	DESCRIPTION
GPS Store Rate {GPSSTR} (only applicable with optional GPS)	325	10 0=OFF (No Storage) 1=Every second 2=Every 2 seconds ... up to once every 20 seconds	<i>Note: When GPSSTR = 10 seconds, the NT 460 has enough memory to store approximately 400 loads (32.5 hours) of GPS weight information.</i>
Acres Accumulated {ACRES}	327	0	Shows running total of acres.
MENU 4. PRESET, BATCHING & ROTATION COUNTER FEATURES			
Buzzer {BUZZER}	404	OFF , 1,2,3,4	Adjust tolerance alarm setting
Tolerance {TOLER}	442	OFF , .5, 1, 2, 5 etc.	Front panel light and beeper periodically sound when Actual Application Rate varies from set Rate
CALIBRATION			
Setup Number {SETUP}	871		Quick entry method selects weigh method 1-4lbs, 5-8kg, gain 1-9, display counts 1-9 and capacity *1000.
Calibration Number {CAL}	872		Weight displayed at .4mV/V for these load cells.

RE-CALIBRATING YOUR SCALE

To re-calibrate your scale and make it even more accurate, document at least 3 to 6 loads of varying sizes and measure the actual weight of all loads on a certified scale.

- Weigh the load immediately before unloading and immediately after unloading to minimize errors due to changes in fuel etc.

In this example, we are unloading six carts of nutrient onto four semi-trucks.

Example:

	Indicator Weight	Certified Scale Weight
Cart Load A	33660	33900
Cart Load B	33240	33540
Cart Load C	<u>35200</u>	<u>35480</u>
Total Weight	102100	102920

Reading Too High

If the Indicator is reading higher than the certified scale, then the calibration number is high and should be decreased proportionally. See page 38.

Reading Too Low

If the Indicator is reading lower than the certified scale, then the calibration number is low and should be increased proportionally. See page 38.

Get Your Calibration Number



1. Enter **872** and press . The calibration (**CAL**) number will display. Example **CAL = 24280**.



$$\frac{\text{TOTAL CERTIFIED WEIGHT}}{\text{TOTAL INDICATOR WEIGHT}} \times \text{CURRENT CAL NUMBER} = \text{NEW CAL NUMBER}$$

Using the previous example your results would be:

$$\frac{102920}{102100} \times 24280 = 24475$$

Change Setup and Calibration Numbers



1. Enter **872** and press .
2. Indicator shows **SETUP** briefly then show a 6 digit number. Enter new number.
3. Press .

For best results, unload on level ground. Make sure no nutrient is lost in trucking the nutrient to a certified scale.

INSTALLATION

Indicator Mounting

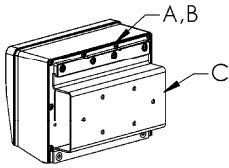

RAIL MOUNT

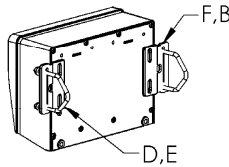

WING MOUNT

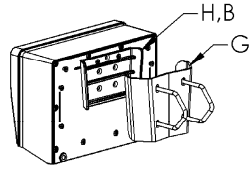

WEDGE MOUNT

KEY	PART NUMBER	DESCRIPTION
A	404353	BRACKET-EZ3 PLASTIC RAIL *
B	403780	SCR-#10 X 5/8 FHSTS BLACK ZP
C	840459	SUPPORT-HAT BRACKET
D	405069	U-BOLT 1/4-20 X 3.25 ZP
E	405084	NUT-1/4-20 TOP LOCKING FLANGE
F	403770	BRACKET- WING MOUNT *
G	405124	PACK-WEDGE MOUNT BRACKET WITH U-BOLTS & FLANGE NUTS
H	405244	EZ3 WEDGE MOUNT

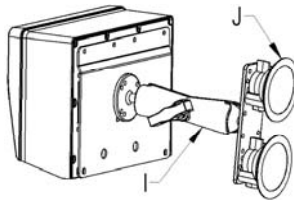

RAM MOUNT

KEY	PART NUMBER	DESCRIPTION
I	404799	RAM MOUNT FOR EZ III INDICATOR WITH HARDWARE
J	404230	RAM SUCTION CUP W/TWIST LOCK

* Included with indicator.

Cable Connection

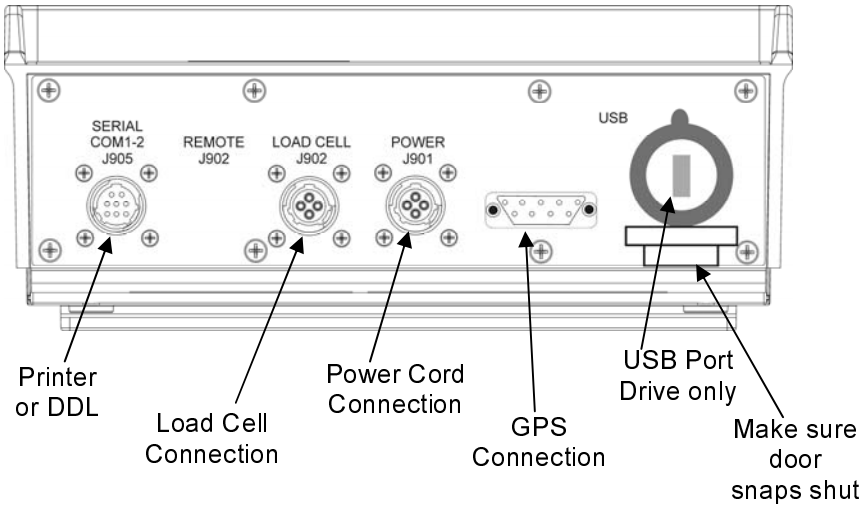

Pin	To 12VDC Power Supply	
1	Red	+Terminal
2	Black	-Terminal
3	Orange	Alarm Out
4	Blue	Remote Input

Bottom Panel Cable Connections

Connect Load Cells to J-Box

Connect load cell wires to terminal blocks. See Wire Color Key

Wire Color Key		
	Color	Description
1	White	Signal +
2	Green	Signal -
3	Red	Excitation +
4	Black	Excitation -
5	Shield	Shield

J-Box Illustrated for 4 Load Cell Installation

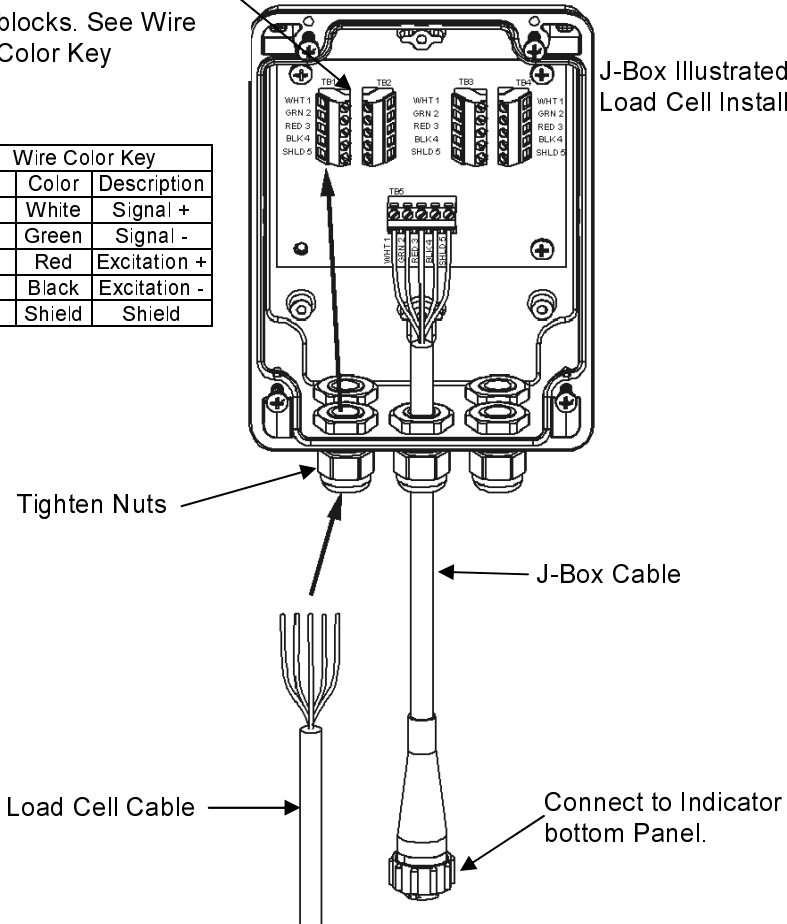

J-Box Connections